

PANBETON®

FICHE TECHNIQUE

Panbeton® est une technologie exclusive de panneaux ultraléger en béton. Ces plaques se travaillent, au niveau des murs, de manière très efficace et rapide. C'est l'outil idéal pour habiller son espace de béton.

-
- Une plaque de grande dimension légère et redécoupable
 - Une face avant en véritable béton brut
 - Un système d'accroche simple
 - Une mise en oeuvre rapide avec peu de manutention
 - Des possibilités de sur-mesure infinies

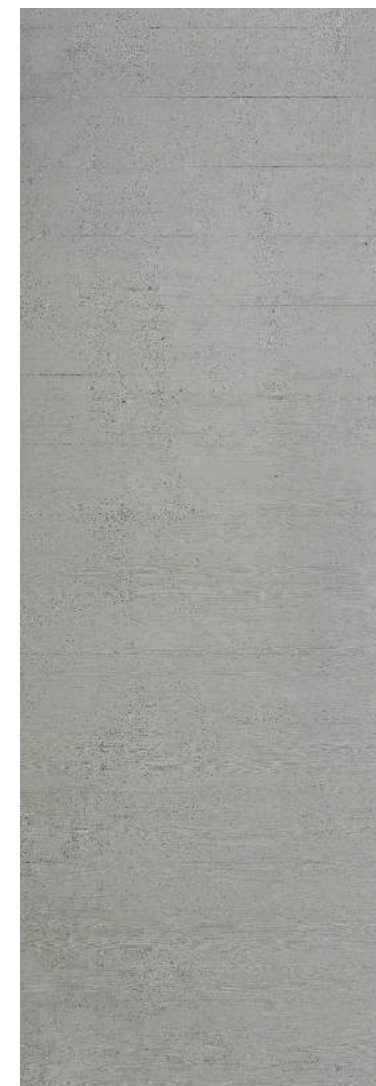

BOIS HORIZONTAL
MATALI CRASSET

Dimension disponible :
2600 x 900 mm

PANBETON® BOIS HORIZONTAL

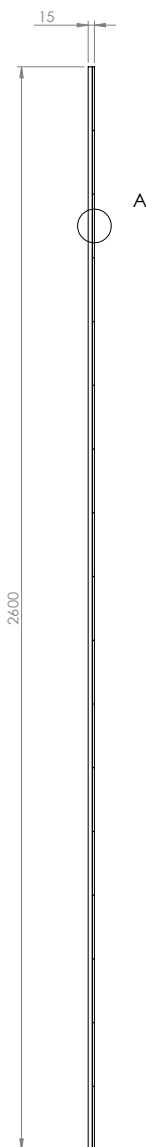
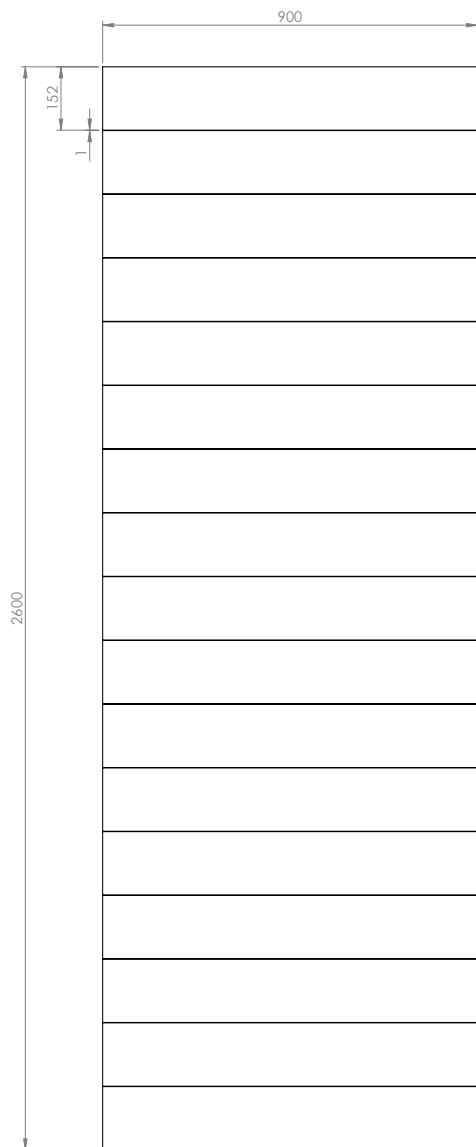

DÉTAIL A
ECHELLE 1 : 1

DETAIL A
SCALE 1 : 1

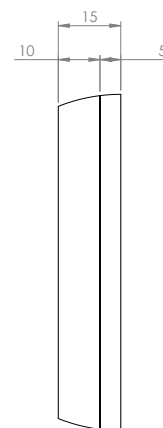

Dimensions *selon modèles*
2600x900 mm



Orthogonalité
+/- 1.0%



Épaisseur *selon modèles*
15 mm à 20 mm



Poids
30 Kg



Surface
+/- 1.0%



Fixation
Collage



Résistance au feu
Euroclass B-s1, d0 // ASTM
E84 : Class A / Smoke index :
0 / Flame spread index : 0



Gel et dégel
Stable



Choc thermique
Résistant



Résistance à la lumière
Pas d'influence

PANBETON® NUANCIER

COLORIS



402 - Blanc



404 - Pierre



216 - Gris Anthracite



200 - Gris Naturel

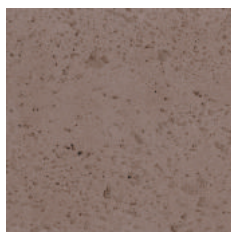

205 - Marron

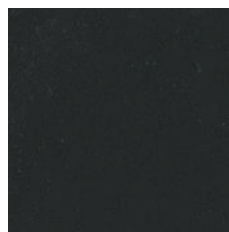

209 - Noir



217 - Gris moyen

FINITIONS



Brut Faible



Brut Moyen

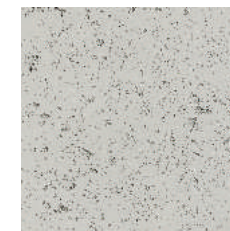

Brut Fort

PANBETON® DONNÉES TECHNIQUES

DIMENSIONS	2600mm x 900mm
ÉPAISSEUR	15 mm à 20 mm
POIDS TOTAL	30 Kg
POIDS AU M²	De 11 à 14 kg/m ²
CLASSIFICATION AU FEU	Euroclass B-s1, d0 // ASTM E84 : Class A / Smoke index : 0 / Flame spread index : 0
CLASSIFICATION COV	A+
EXCLUSION	Extérieur et cabine de douche
COMPOSITION	Béton fibré (5 mm) & panneau de construction (10 mm)
TRAITEMENT DE PROTECTION	En option (Base acrylique en phase aqueuse)
FIXATION	Collage – Collage + Vissage pour plafonds
SUPPORTS	Se colle sur tous les supports (Placopatre®, brique, parpaing, etc.)
COLLE	Hybrifix 550 DEN BRAVEN
DÉCOUPE	Disque diamant. Possibilité de coupe onglet, percage, scie cloche...

PANBETON® DÉTAILS SPÉCIFIQUES

NOM DU PRODUIT : Panbeton® Bois Horizontal

NOM DE L'ENTREPRISE : Concrete LCDA

DONNÉES TECHNIQUES MORTIER :

- Mortier de réparation fibré à retrait compensé

Mortier à retrait compensé constitué de sables, de ciments spéciaux, de fibres et d'additifs.

Résistance en compression : Class R2

Teneur en ions chlorure : $\leq 0.05\%$

Adhérence : ≥ 0.8 MPa

Réaction au feu : Euroclass B-s1, d0 // ASTM E84:

Class A / Smoke index : 0 / Flame spread index : 0

DONNÉES TECHNIQUES FIBRE DE RENFORT :

- Teneur de 17% en Zircon + Fibre de verre Alcali résistant

DONNÉES TECHNIQUES PANNEAU DE

CONSTRUCTION :

Noyau bleu en mousse dure de polystyrène extrudé. La mousse dure est armée sur les deux faces d'un tissu en fibres de verre et enduite d'un mortier plastifié.

UTILISER CETTE DESCRIPTION POUR MENTIONNER NOS PRODUITS.

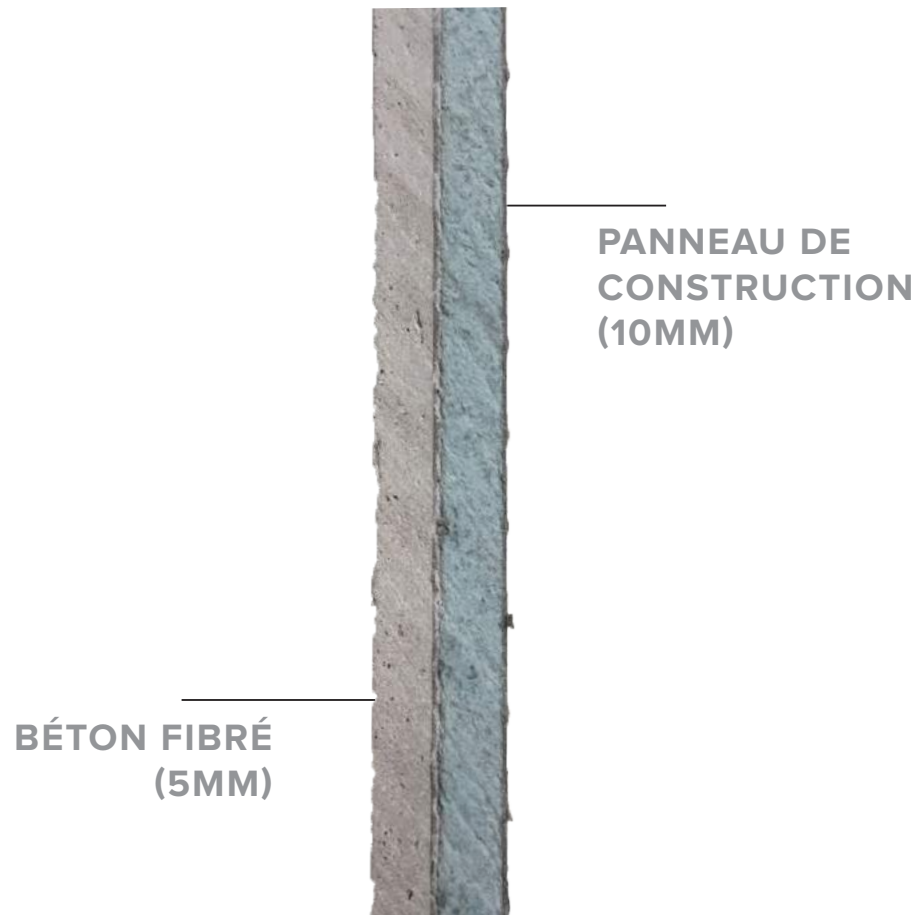

PANBETON® COUPES D'ANGLES

ANGLE SORTANT

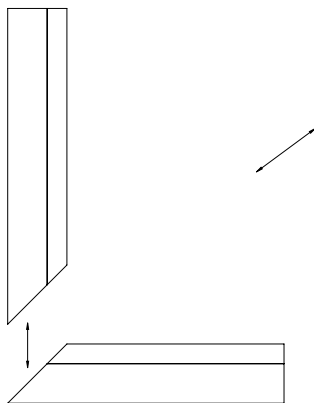
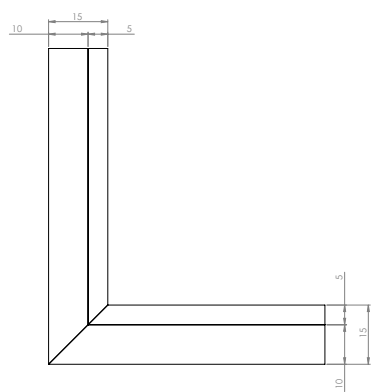
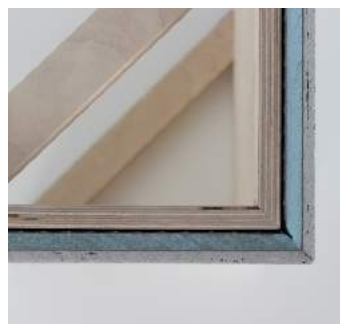

CORNIÈRE EN SANDWICH

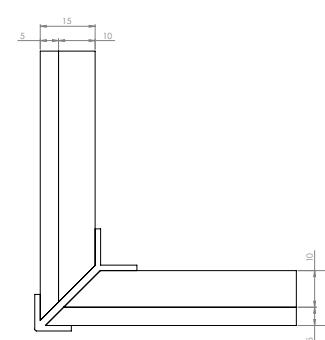
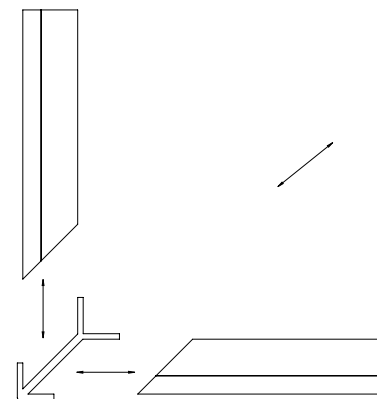

PANBETON® COUPES D'ANGLES

CORNIÈRE PAR-DESSUS

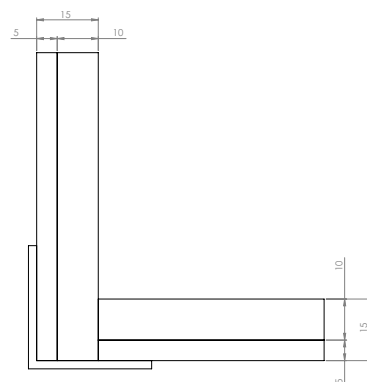
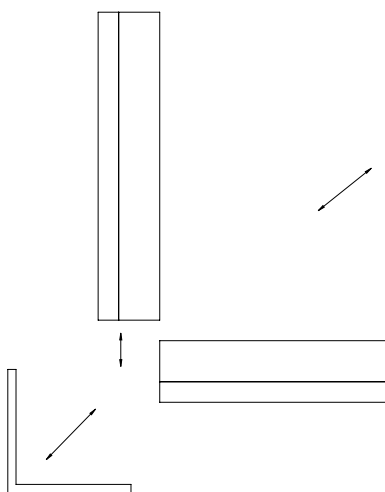

COUPE BORD À BORD

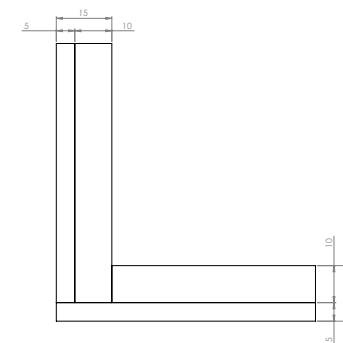
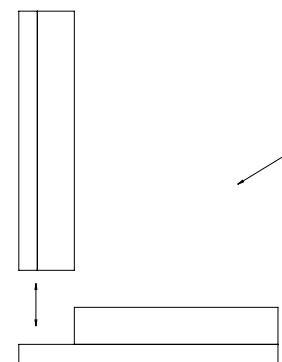

PANBETON® MATÉRIEL D'INSTALLATION

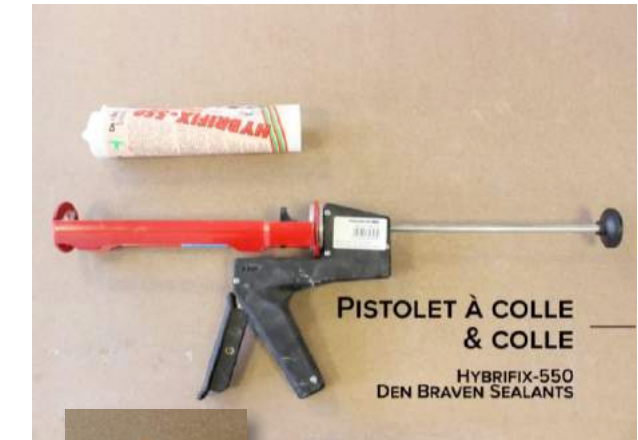
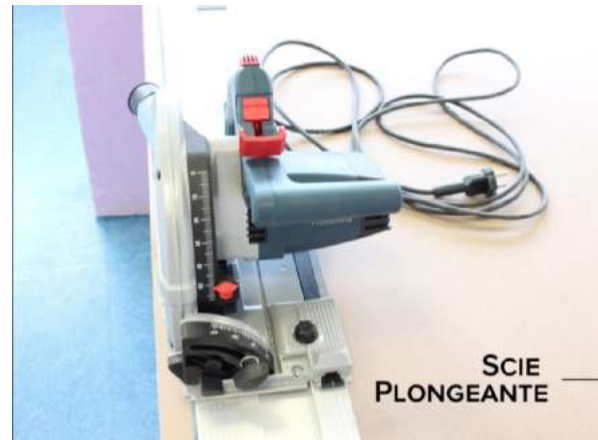

HYBRIFIX-550
DEN BRAVEN SEALANTS

PANBETON® ÉTAPES D'INSTALLATION



NE PAS OUBLIER DE DÉPOUSSIÉRER LES PANNEAUX APRÈS L'INSTALLATION

VIDÉO COMPLÈTE : [HTTPS://WWW.YOUTUBE.COM/WATCH?V=U-IZ5ocQw-w](https://www.youtube.com/watch?v=U-IZ5ocQw-w)

CONCRETE LCDA

CONTACT

CONTACT@CONCRETE-BETON.COM

WWW.CONCRETE-BETON.COM