

PANBETON®

TECHNICAL DATA SHEET

Panbeton® is a unique technology of ultra-lightweight concrete cladding. These slabs are quick and easy to install. It is the ideal covering to dress up a space with concrete. A large lightweight and easy to cut slab.

-
- Front made of genuine raw concrete
 - A simple attachment system
 - Quick installation with little handling
 - Endless customisation possibilities



SHUI 水
NERI&HU

Available dimension :
2600 x 900 mm

PANBETON® SHUI 水

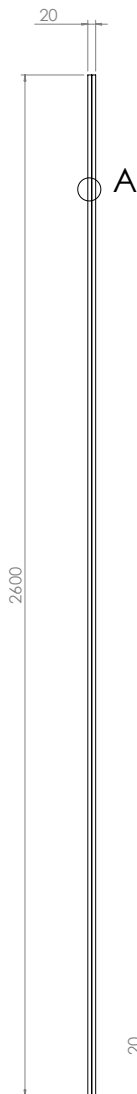
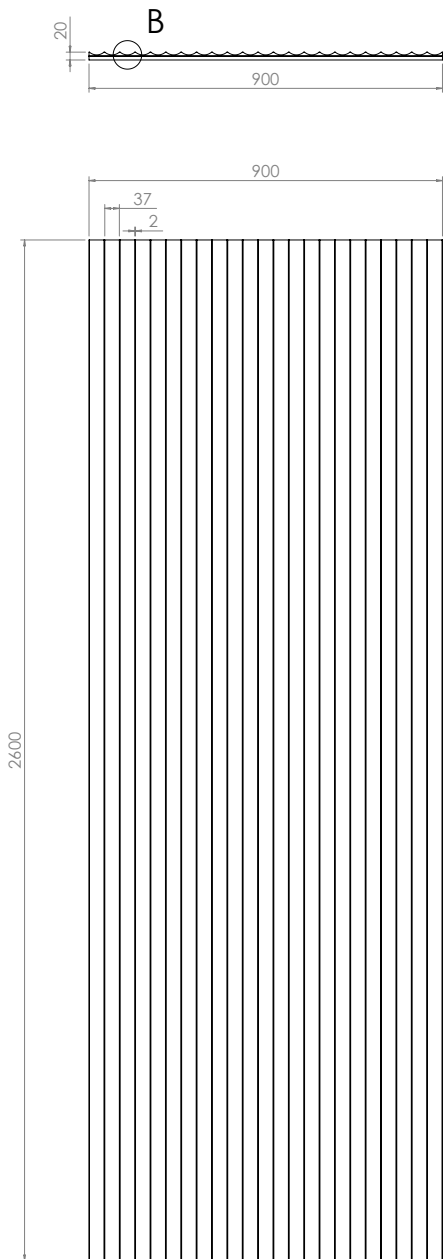

DÉTAIL A
ECHELLE 1:1
DETAIL A
SCALE 1:1

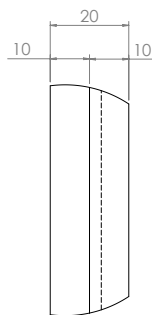

DÉTAIL B
ECHELLE 1:1
DETAIL B
SCALE 1:1

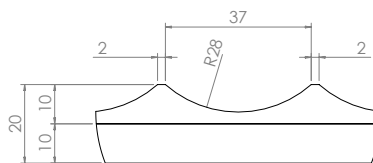

Dimensions according to model
2600x900 mm



Orthogonality
+/- 1.0%



Thickness according to model
15 mm to 20 mm



Weight
30 Kg



Surface area
+/- 1.0%



Mounting
Bonding



Fire resistance
Euroclass B-s1, d0 //
ASTM E84 : Class A /
Smoke index : 0 / Flame
spread index : 0



Freezing and thawing
Stable



Thermal shock
Resistant



Light resistance
No impact

PANBETON® COLOUR CHART

COLOURS



402 - White



404 - Stone

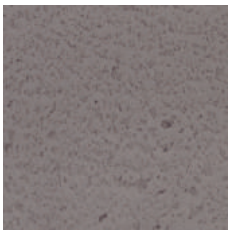

216 - Anthracite grey

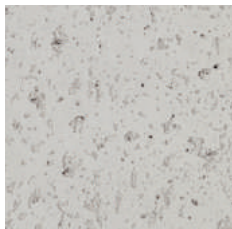

200 - Natural grey

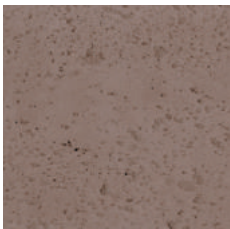

205 - Brown

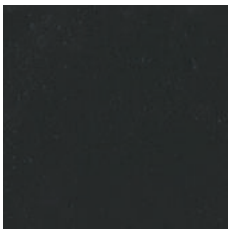

209 - Black



217 - Slate grey

FINISHES

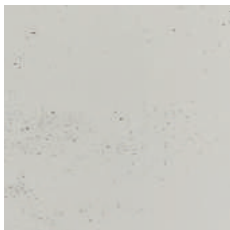

Light pitted



Medium pitted

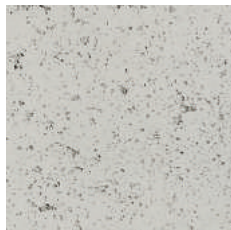

Heavy pitted

PANBETON® TECHNICAL DATA

DIMENSIONS	2600mm x 900mm
THICKNESS	15 mm to 20 mm
TOTAL WEIGHT	30 Kg
WEIGHT PER M²	From 11 to 14 kg/m ²
FIRE CLASSIFICATION	Euroclass B-s1, d0 // ASTM E84 : Class A / Smoke index : 0 / Flame spread index : 0
VOC CLASSIFICATION	A+
EXCLUDED	Exterior and shower stall
COMPOSITION	Fibre-reinforced concrete (5 mm) & construction panel (10 mm)
PROTECTIVE SEALER	As an option (water-borne acrylic base)
FIXING	Gluing – Gluing + Screwing for ceilings
SUBSTRATES	Is glued to all substrates (Plasterboard, bricks, breeze-blocks, etc.)
GLUE	Hybrifix 550 DEN BRAVEN
CUTTING	Diamond blade, mitre, drilling, hole saw and others possible

PANBETON® SPECIFICATIONS DETAILS

PRODUCT NAME: Panbeton® Shui 水

COMPANY NAME: Concrete LCDA

TECHNICAL DATA MORTAR:

- Fibre-Reinforced shrinkage-compensating repair mortal

Non-shrinking mortal composed of sand, special cement, fibres and admixtures.

Compressive strength: Class R2

Chloride ion content: ≤ 0.05%

Bonding: ≥ 0.8 MPa

Reaction to fire: Euroclass B-s1, d0 // ASTM E84 :
Class A / Smoke index : 0 / Flame spread index : 0

TECHNICAL DATA REINFORCED FIBER:

- High Zirconia 17%+ Alkali Resistant Glass Fibre

TECHNICAL DATA CONSTRUCTION

PANEL:

Rigid extruded polystyrene foam finished on both sides with a polymer-modified mortar facing, reinforced with a glassfibre mesh fabric.



**CONSTRUCTION
PANEL (10MM)**

**FIBRE-REINFORCED
CONCRETE (5MM)**

**USE THIS ENTIRE DESCRIPTION TO
SPECIFY OUR PRODUCTS.**

PANBETON® CORNER CUTTING

OUTER CORNER

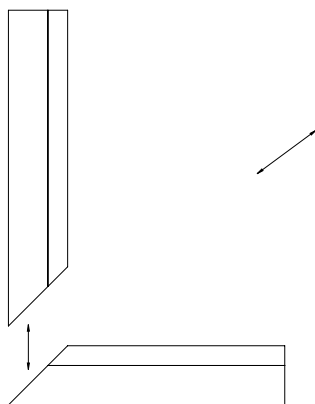
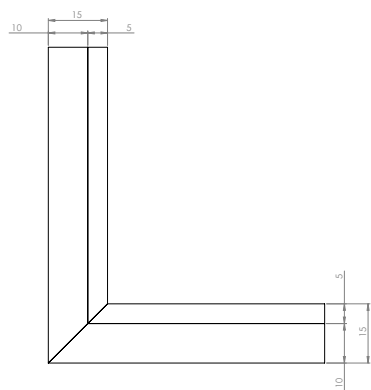
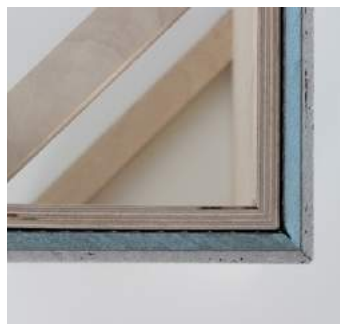

IRON CORNER

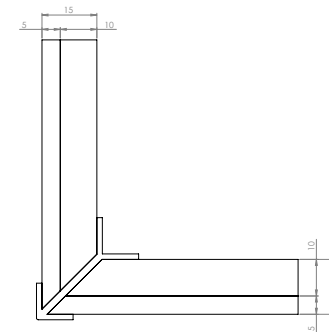
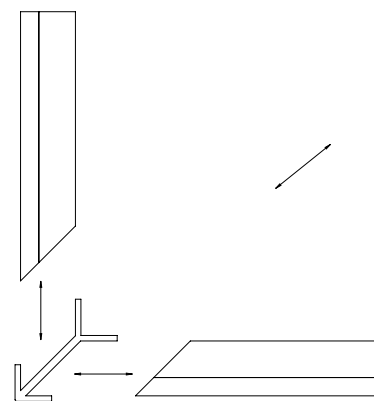

PANBETON® CORNER CUTTING

TOP CORNER IRON

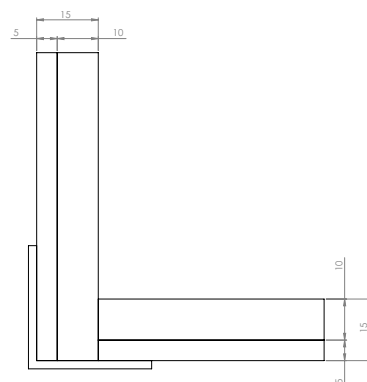
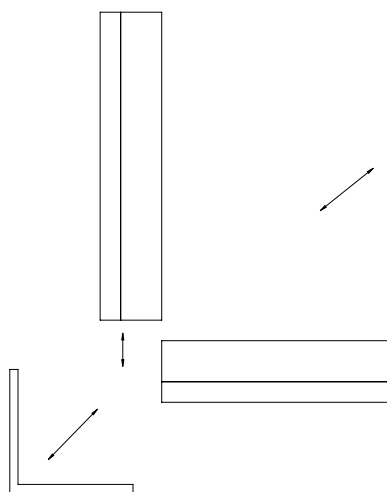

BOARD TO BOARD JOIN

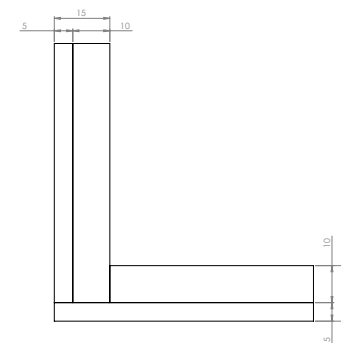
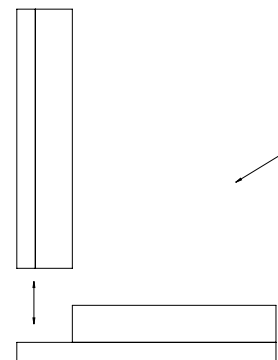

PANBETON® INSTALLATION TOOLS



HYBRIFIX-550
DEN BRAVEN SEALANTS

PANBETON® INSTALLATION STEPS

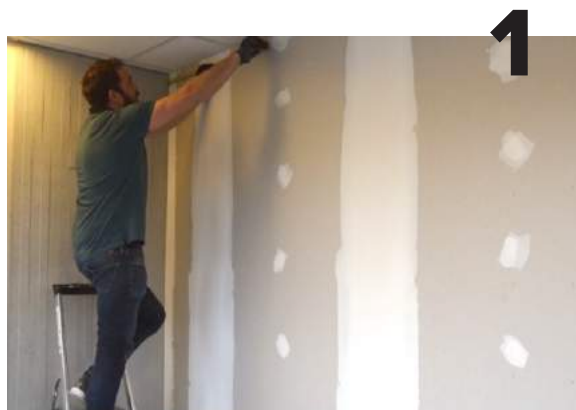

— TAKE WALL MEASUREMENTS BEFORE CUTTING THE PANEL

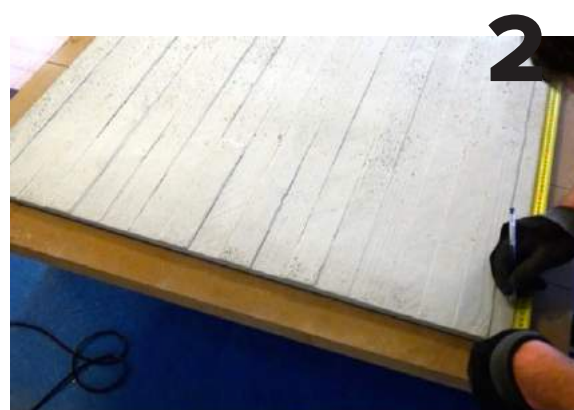

— COPY YOUR MEASUREMENTS ON THE PANBETON®



— START CUTTING WITH A PLUNGE-CUT SAW

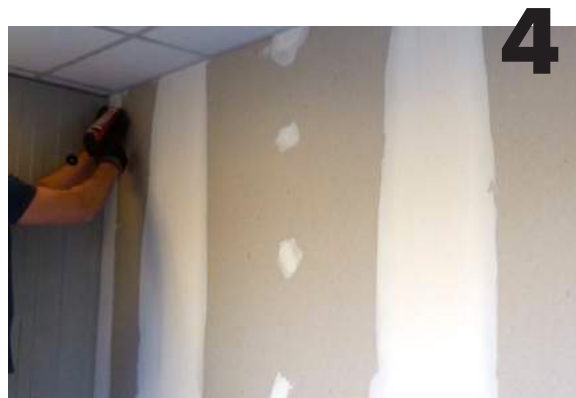

— APPLY GLUE ON THE WALL



— INSTALL THE PANBETON® BY STARTING FROM BOTTOM TO TOP



DO NOT FORGET TO DUST PANELS AFTER FINAL INSTALLATION

CHECK THE ENTIRE VIDEO HERE: [HTTPS://WWW.YOUTUBE.COM/WATCH?V=U-IZ5ocQW-W](https://www.youtube.com/watch?v=U-IZ5ocQW-W)

CONCRETE LCDA

CONTACT

WWW.CONCRETE-BETON.COM

CONTACT@CONCRETE-BETON.COM