



TECHNICAL DATA - ENGLISH

PANBETON® DELICATE

DESIGN : NORMAL STUDIO

DIMENSIONS : 2600 x 900 X 15 mm | 102.36" x 35.43" x 0.59"

CONCRETE LCDA

8 rue Copernic 49240 Avrillé - FRANCE

T. +33 (0) 2 41 33 99 10 F. +33 (0) 9 70 32 65 61

CONTACT@CONCRETE-BETON.COM

WWW.CONCRETE-BETON.COM

PANBETON®

ULTRA-LIGHTWEIGHT CONCRETE CLADDING

Panbeton® is a unique technology of ultra-lightweight concrete cladding. These slabs are quick and easy to install for wall and ceiling covering. It is the ideal covering to dress up a space with concrete.

- > A large lightweight and easy to cut slab.
- > Front made of genuine raw concrete
- > A simple attachment system
- > Quick installation with little handling
- > Endless customisation possibilities.

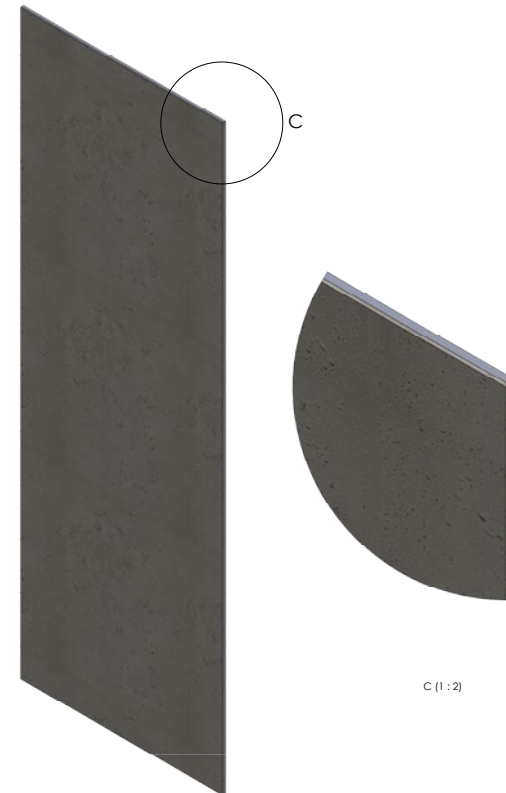

TECHNICAL SHEET (MM)

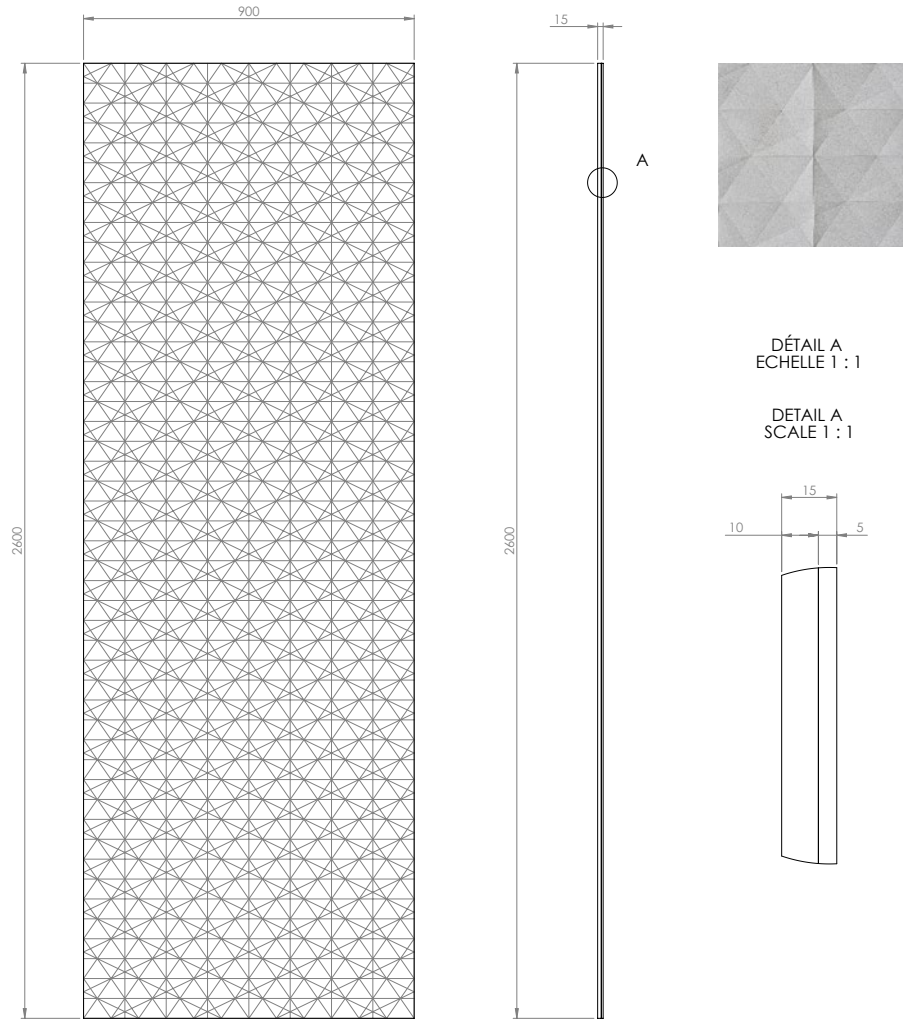

INFORMATIONS TECHNIQUES :

Matière : Béton fibré ultra haute performance
 Poids : 35 Kg
 Tolérance générale +/- 3 mm

TECHNICAL INFORMATIONS :

Material : Fiber High performance concrete
 Weight : 35 kg
 General tolerance : +/- 3 mm

CONCRETE LCDA			8 rue Copernic 49240 Avrillé www.concrete-beton.com
Date	Nom	N°plan	Echelle : Scale :
			Ep :
			PANBETON® DELICATE NORMAL STUDIO
Surface : m ² Units : mm Units : mm			Bon pour accord : Agreement for production :
Poids : Kg Weight : kg			FEUILLE 1 SUR 1 SHEET 1 OF 1

TECHNICAL SHEET (INCH)

EN

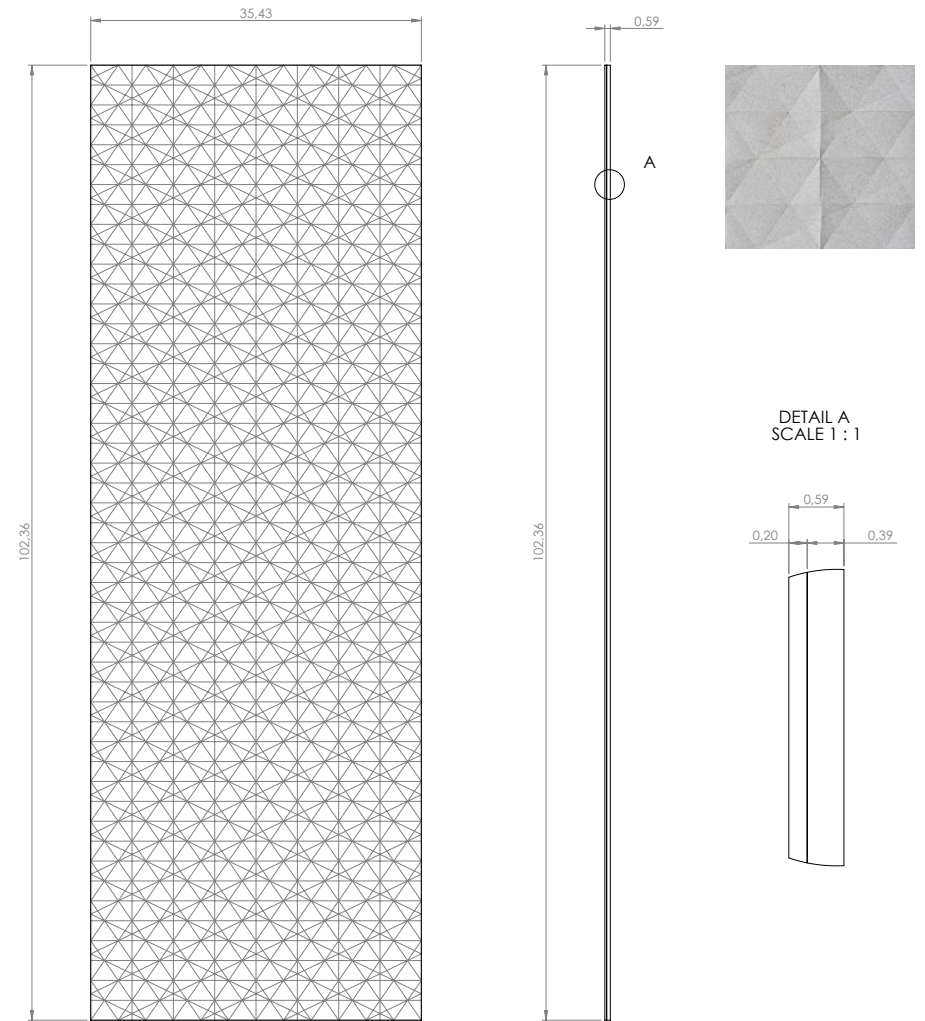









TECHNICAL INFORMATIONS :

Material : Fiber High performance concrete
 Weight : 66 LBS
 General tolerance : +/- 0.12 in

CONCRETE LCDA			8 rue Copernic 49240 Avrillé www.concrete-beton.com
Date	Name	N°plan	Scale :
			Ep :
			PANBETON® DELICATE NORMAL STUDIO
Surface : Units : in			Agreement for production :
Weight : LBS			SHEET 1 OF 1

Ce dessin est la propriété de la société LCDA. Toute reproduction sans notre accord préalable est interdite.
 This drawing is the property of LCDA. Reproduction without our permission is prohibited.

	DIMENSIONS	2600 x 900 mm 102.36" x 35.43" (General tolerance +/- 3 mm 0.12")
	ORTHOGONALITY	+ /- 1.0 %
	SURFACE AREA	+ /- 1.0 %
	THICKNESS	15 mm 0.59"
	WEIGHT	30 Kg 66 lbs (+/- 20 %)
	WEIGHT PER SQM	12 to 18 kg/m² 25 lbs to 30 lbs /m²
	COMPOSITION	> Fibre-reinforced concrete > Construction panel
	SEALER TREATMENT	As an option (water-borne acrylic base)
	MOUNTING & BONDING	Glue Hybrifix 550 DEN BRAVEN
	SUBSTRATES	Is glued to all substrates (plasterboard, bricks, breeze-blocks, etc.)
	CUTTING	Diamond blade (continuous-rim). outer corner possible, drilling with diamond-coated hole saw...

	FIRE CLASSIFICATION	> Euroclass B-s1, d0 > [OPTION] A2-s1d0 (with specific support : gypsum fiber board) > ASTM E84 : Class A Smoke index : 0 Flame spread index : 0
	HEAT RESISTANCE	Up to 60°C Up to 140 °F
	THERMAL SHOCK	Resistant
	LIGHT RESISTANCE	No impact
	VOC CLASSIFICATION	A+
	ACOUSTIC	Neutral
	EXCLUDED	Exterior, floor, shower stall. Not suitable for direct and continuous contact with water.

USE THIS ENTIRE DESCRIPTION TO SPECIFY OUR PRODUCTS.

COMPANY NAME		Concrete LCDA
TECHNICAL DATA	MORTAR	<p>Fibre-Reinforced shrinkage-compensating repair mortar.</p> <p>Non-shrinking mortar composed of sand, special cement, fibres and admixtures.</p> <p>Compressive strength: Class R2 Chloride ion content: $\leq 0.05\%$ Bonding : ≥ 0.8 MPa</p>
	REINFORCED FIBRE	High Zirconia 17%+ Alkali Resistant Glass Fibre.
	CONSTRUCTION PANEL	Rigid extruded polystyrene foam finished on both sides with a polymer-modified mortar facing, reinforced with a glassfibre mesh fabric.

COMPOSITION

Slice view



5 MM | 0.19"

10 MM | 0.39"

FIBRE-
REINFORCED
CONCRETE

CONSTRUCTION
PANEL



FINISHES



Light Pitted



Medium Pitted



Heavy Pitted

COLORS



200 - Natural Grey



217 - Slate Grey



216 - Anthracite Grey

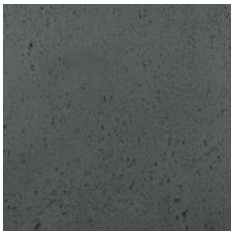

209 - Black



402 - White



404 - Stone



205 - Brown



269 - Luzerne



473 - Ouarzazate

CORNER CUTTING

1 - BOARD TO BOARD JOIN



Front view

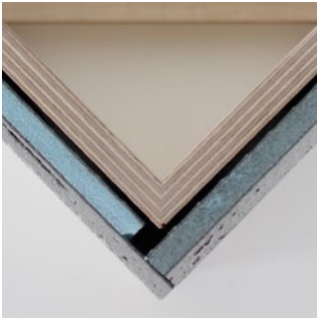

Top view

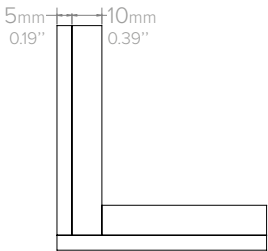

Schema

3 - TOP CORNER IRON



Front view

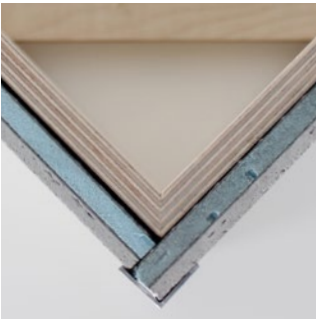

Top view

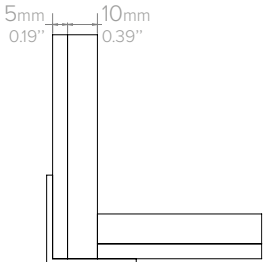

Schema

2 - OUTER CORNER*

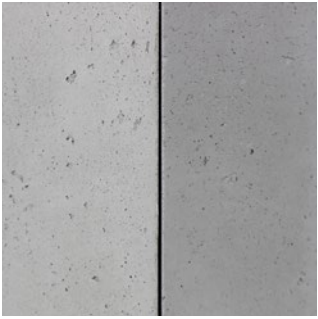

Front view

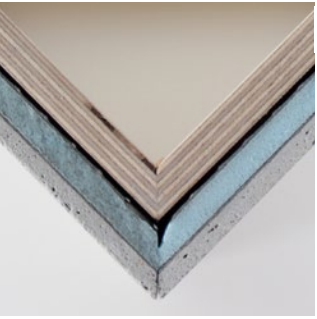

Top view

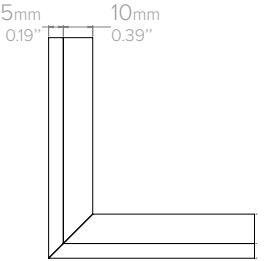

Schema

4 - IRON CORNER*



Front view

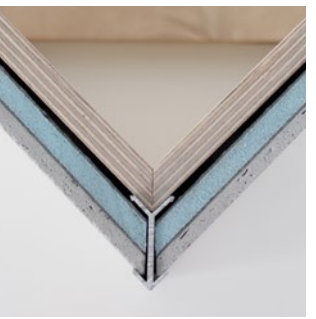

Top view

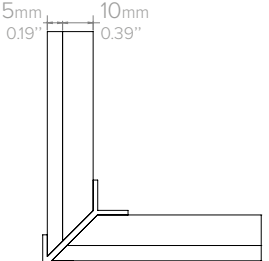

Schema

*45 degree cuts can be made at the Concrete LCDA factory (as an option).



INSTALLATION TOOLS

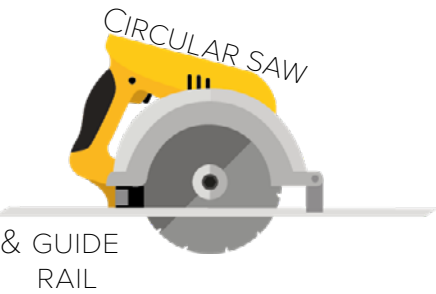
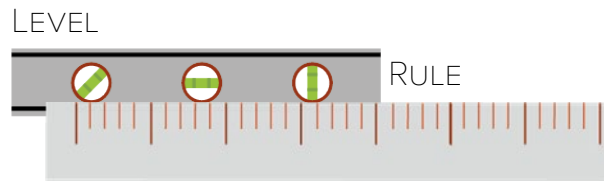
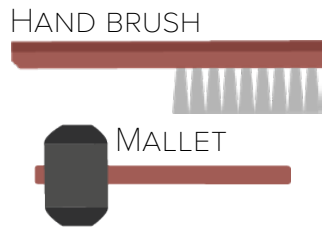

INSTALLATION STEPS

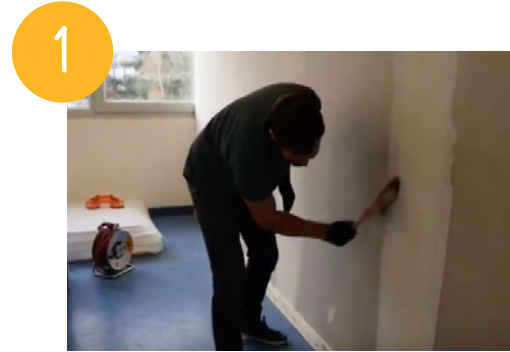

CLEAN THE AREA BEFORE THE INSTALLATION

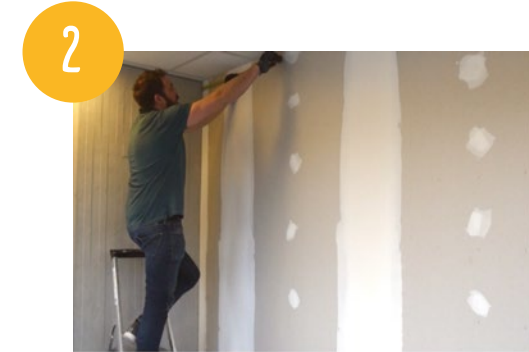

TAKE WALL MEASUREMENTS BEFORE CUTTING THE PANEL

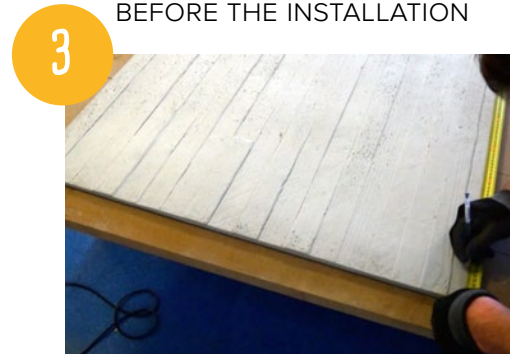

COPY YOUR MEASUREMENTS ON THE PANEL



CUTTING WITH THE USE OF A GUIDE RAIL

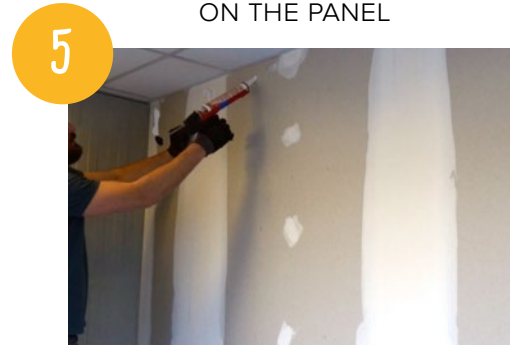

APPLY GLUE ON THE WALL (OR ON THE BACK OF THE PANEL)

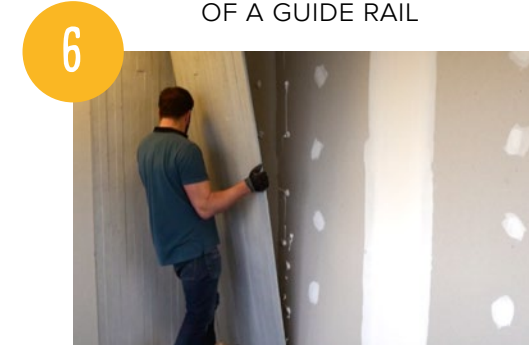

PLACE THE PANEL STARTING WITH THE BOTTOM

INSTALLATION VIDÉOS STEP BY STEP TO SEE
ON OUR YOUTUBE CHANNEL @CONCRETE LCDA

