

# PANBETON®

## TECHNICAL DATA SHEET

Panbeton® is a unique technology of ultra-lightweight concrete cladding. These slabs are quick and easy to install. It is the ideal covering to dress up a space with concrete. A large lightweight and easy to cut slab.

- 
- Front made of genuine raw concrete
  - A simple attachment system
  - Quick installation with little handling
  - Endless customisation possibilities



**CHEVRONS**  
JEAN-PHILIPPE NUEL

Available dimensions :  
2600 x 900 mm

# PANBETON® CHEVRONS

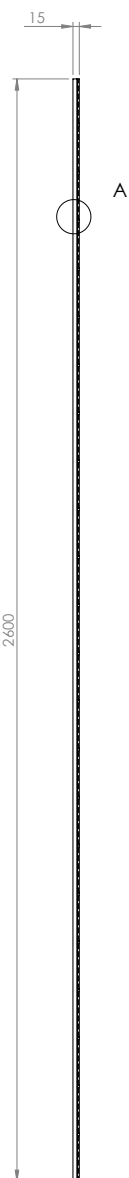
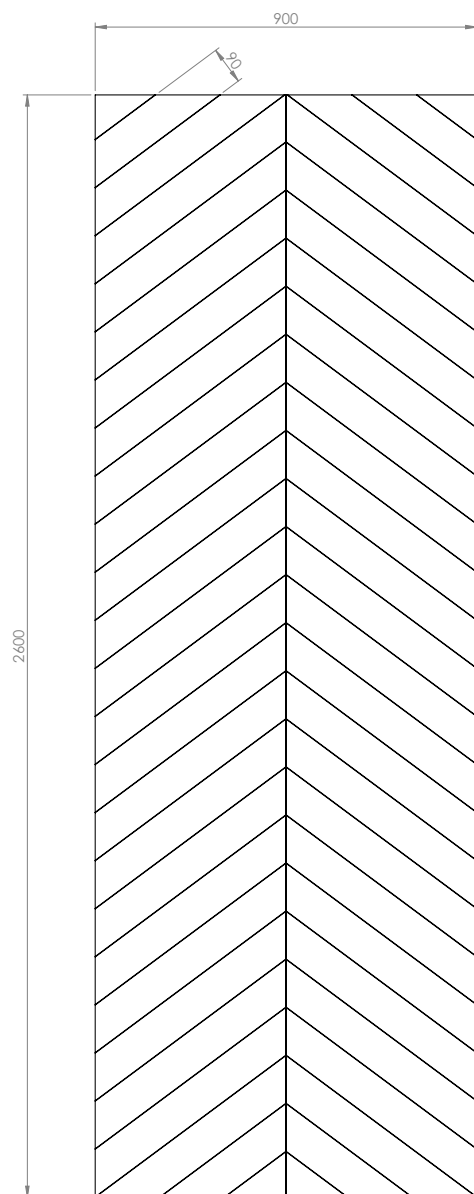

Trois variations de modèles de lames possible

Three variations of models of blades possible

SCALE 1:1  
DETAIL A

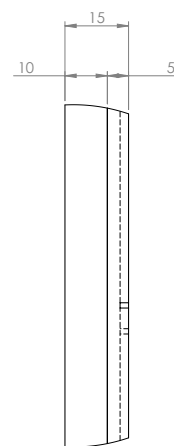

Dimensions *according to model*  
2600mm x 900mm



Orthogonality  
+/- 1.0%



Thickness *according to model*  
15 mm to 20 mm



Weight  
35 Kg



Surface area  
+/- 1.0%



Mounting  
Bonding



Fire resistance  
Euroclass B-s1, d0 // ASTM E84 : Class A / Smoke index : 0 / Flame spread index : 0



Freezing and thawing  
Stable



Thermal shock  
Resistant



Light resistance  
No impact

# PANBETON® COLOUR CHART

## COLOURS



402 - White



404 - Stone

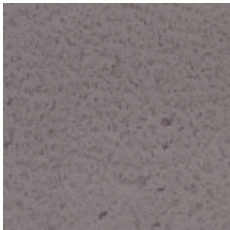

216 - Anthracite grey

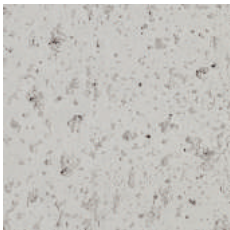

200 - Natural grey

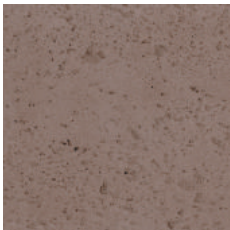

205 - Brown

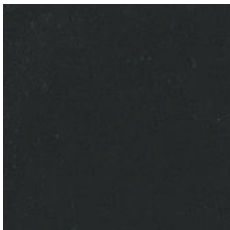

209 - Black

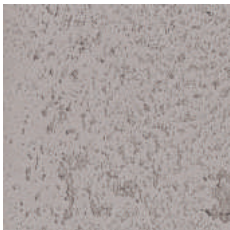

217 - Slate grey

## FINISHES



Light pitted



Medium pitted

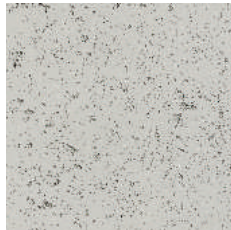

Heavy pitted

# PANBETON<sup>®</sup> TECHNICAL DATA

<b>DIMENSIONS</b>	2600mm x 900mm
<b>THICKNESS</b>	15 mm to 20 mm
<b>TOTAL WEIGHT</b>	35 Kg
<b>WEIGHT PER M<sup>2</sup></b>	From 11 to 14 kg/m <sup>2</sup>
<b>FIRE CLASSIFICATION</b>	Euroclass B-s1, d0 // ASTM E84 : Class A / Smoke index : 0 / Flame spread index : 0
<b>VOC CLASSIFICATION</b>	A+
<b>EXCLUDED</b>	Exterior and shower stall
<b>COMPOSITION</b>	Fibre-reinforced concrete (5 mm) & construction panel (10 mm)
<b>PROTECTIVE SEALER</b>	As an option (water-borne acrylic base)
<b>FIXING</b>	Gluing – Gluing + Screwing for ceilings
<b>SUBSTRATES</b>	Is glued to all substrates (Plasterboard, bricks, breeze-blocks, etc.)
<b>GLUE</b>	Hybrifix 550 DEN BRAVEN
<b>CUTTING</b>	Diamond blade, mitre, drilling, hole saw and others possible



# PANBETON® SPECIFICATIONS DETAILS

**PRODUCT NAME:** Panbeton® Chevrons

**COMPANY NAME:** Concrete LCDA

## **TECHNICAL DATA MORTAR:**

- Fibre-Reinforced shrinkage-compensating repair mortar

Non-shrinking mortar composed of sand, special cement, fibres and admixtures.

Compressive strength: Class R2

Chloride ion content: ≤ 0.05%

Bonding: ≥ 0.8 MPa

Reaction to fire: Euroclass B-s1, d0 // ASTM E84 :  
Class A / Smoke index : 0 / Flame spread index : 0

## **TECHNICAL DATA REINFORCED FIBER:**

- High Zirconia 17%+ Alkali Resistant Glass Fibre

## **TECHNICAL DATA CONSTRUCTION**

### **PANEL:**

Rigid extruded polystyrene foam finished on both sides with a polymer-modified mortar facing, reinforced with a glassfibre mesh fabric.



**CONSTRUCTION  
PANEL (10MM)**

**FIBRE-REINFORCED  
CONCRETE (5MM)**

**USE THIS ENTIRE DESCRIPTION TO  
SPECIFY OUR PRODUCTS.**

# PANBETON® CORNER CUTTING

## OUTER CORNER

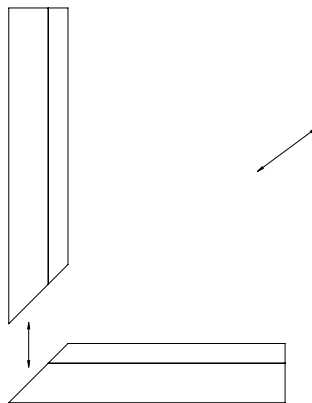
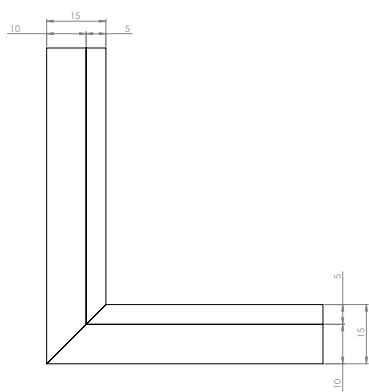
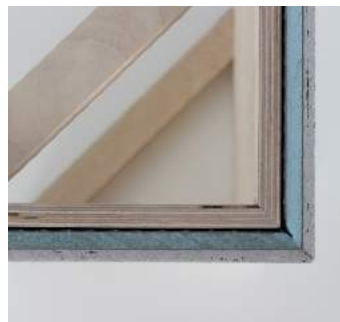

## IRON CORNER

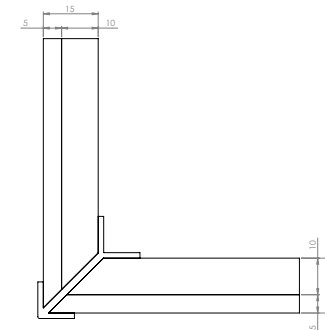
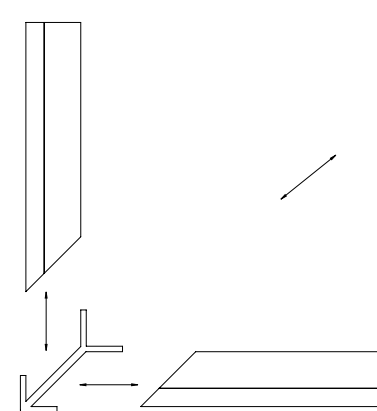

# PANBETON® CORNER CUTTING

## TOP CORNER IRON

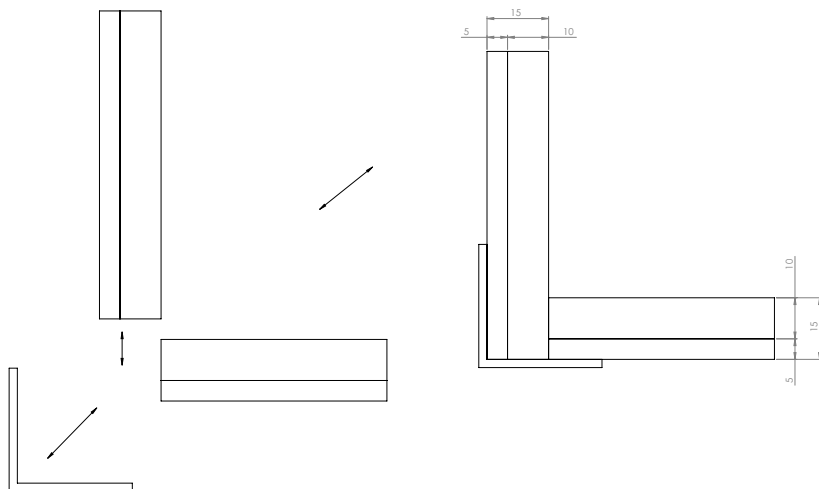

## BOARD TO BOARD JOIN

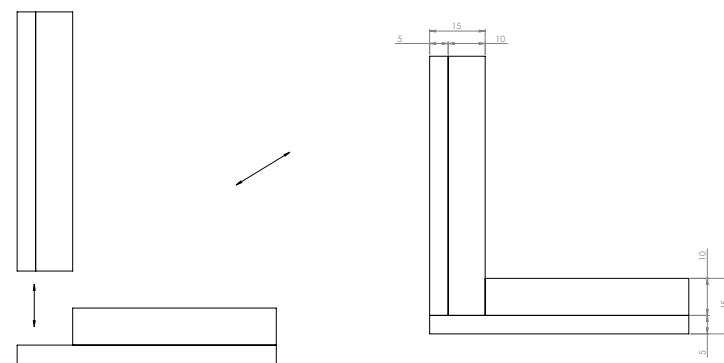

# PANBETON® INSTALLATION TOOLS



CIRCULAR  
SAW TOOL



MALLET & HAND BRUSH



LEVEL, GUIDE & CARPENTER RULE



DIAMOND BLADE WITH A FINE GRIT  
& REDUCER RING

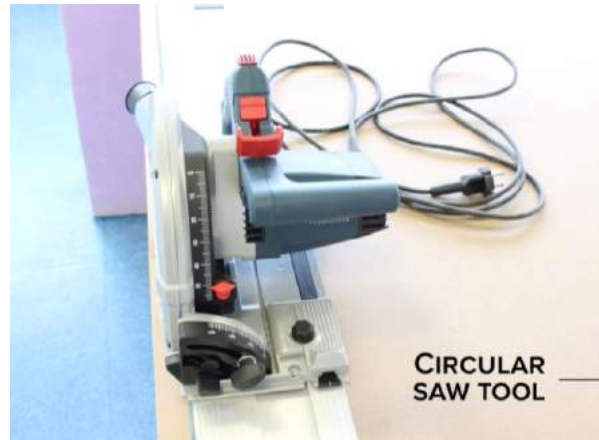

CIRCULAR  
SAW TOOL



GLUE GUN  
& GLUE CARTRIDGE  
HYBRIFIX-550  
DEN BRAVEN SEALANTS



HYBRIFIX-550  
DEN BRAVEN SEALANTS



# PANBETON® INSTALLATION STEPS

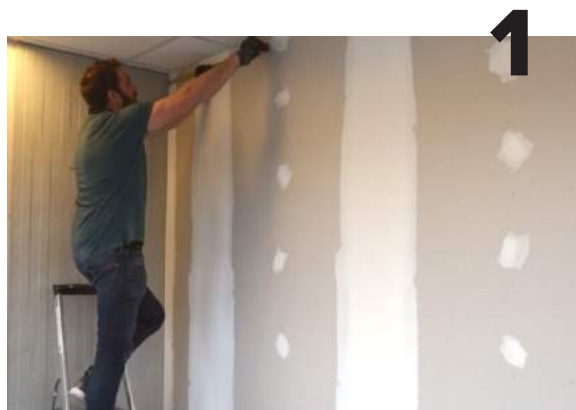

— TAKE WALL MEASUREMENTS BEFORE CUTTING THE PANEL

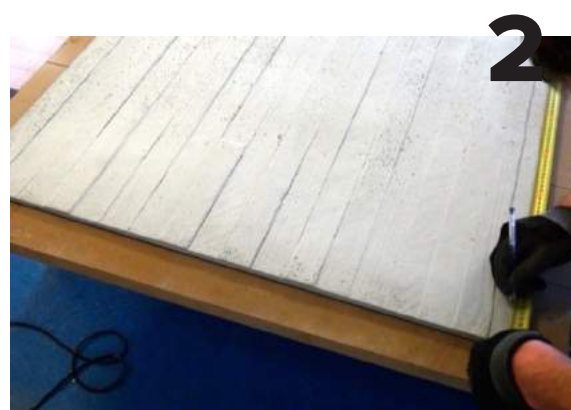

— COPY YOUR MEASUREMENTS ON THE PANBETON®



— START CUTTING WITH A PLUNGE-CUT SAW

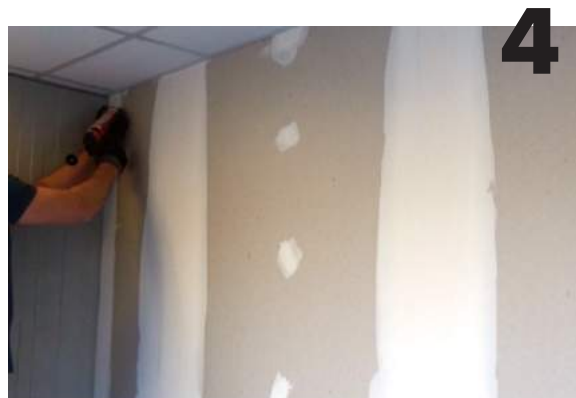

— APPLY GLUE ON THE WALL

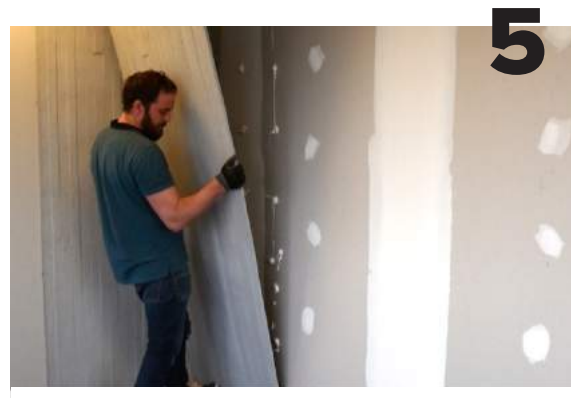

— INSTALL THE PANBTON® BY STARTING FROM BOTTOM TO TOP



**DO NOT FORGET TO DUST PANELS AFTER FINAL INSTALLATION**

CHECK THE ENTIRE VIDEO HERE: [HTTPS://WWW.YOUTUBE.COM/WATCH?V=U-IZ5ocQW-W](https://www.youtube.com/watch?v=U-IZ5ocQW-W)

**CONCRETE LCDA**

## **CONTACT**

**[WWW.CONCRETE-BETON.COM](http://WWW.CONCRETE-BETON.COM)**

**[CONTACT@CONCRETE-BETON.COM](mailto:CONTACT@CONCRETE-BETON.COM)**